



AASTRA

9116LP User Guide



- Introduction 1**
 - Emergency Service Feature 1
 - Unpacking your phone 1
 - Key Descriptions 2
- Basic Installation 4**
 - Installation – Line Power PBX 6
- Making and Answering Calls 7**
 - Making a call 7
 - Answering a Call 7
 - Using the Hold Key 7
 - Making a Handsfree call 7
 - Muting a Handsfree call 8
 - Disable Handsfree Option 8
 - Using Redial 8
 - Call Waiting ID 9
 - Changing the display language 9
 - Setting the date and time 10
 - Adjusting the Handset and Speaker volume 10
 - Adjusting the Ringer Volume 10
 - Adjusting the Display Contrast 10
 - Set Indicator Light 10
- Directory 11**
 - Saving numbers and names to the Directory 11
 - Entering Names 11
 - Making a call from the Directory 12
 - Finding items in the Directory 12
 - Deleting items from the Directory 12
- Callers List 13**
 - Using the Callers List 13
 - Finding a Callers Record in the Callers List 13
 - Making a call from the Callers List 13
 - Editing in the Callers List 14
- Memory keys 15**
 - Saving numbers and names into memory keys 15
 - Viewing memory key contents 15
 - Labeling the memory keys 16
 - Making calls from memory keys 16
 - Deleting memory keys 16
 - Saving features in memory keys 17
 - Saving a feature and light in memory keys 17
- Advanced Features 19**
 - Clear Message Waiting 19
 - Set Area Code 19
 - Turning the Call timer on or off 20
- Display Icons and Messages 21**
 - Icons in the Callers List 21
 - Display messages 21
- Troubleshooting 22**

Introduction

Congratulations..... on the purchase of your 9116LP telephone.

This guide contains operating information for your 9116LP.

The 9116LP is an advanced single-line telephone, that offers the following features:

- Line Powered capability
- Handsfree (speakerphone) option with mute capabilities
- 80 name and number Callers List
- Personal Directory for 20 name and number directory
- 15 speed dial positions for frequently called numbers or feature access codes
- Last number redial
- Class and voltage message waiting indication



Emergency Service Feature

The Model 9116LP will provide most basic telephone service features in the event of a power failure. However, the light indication for message waiting and feature light on/off will not function during a power outage.

Unpacking your phone

Along with this user guide and the feature card, the following items are included with your telephone.

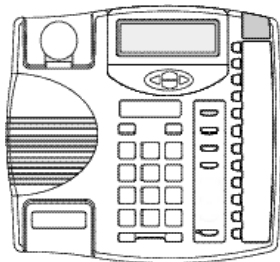

Telephone



Handset

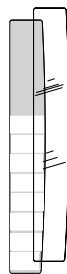

Memory key card
and plastic lens

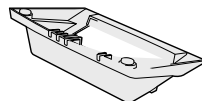

Telephone stand



Number card
and plastic lens



Power adaptor



Short
line cord



Telephone
line cord



Regulatory sheet









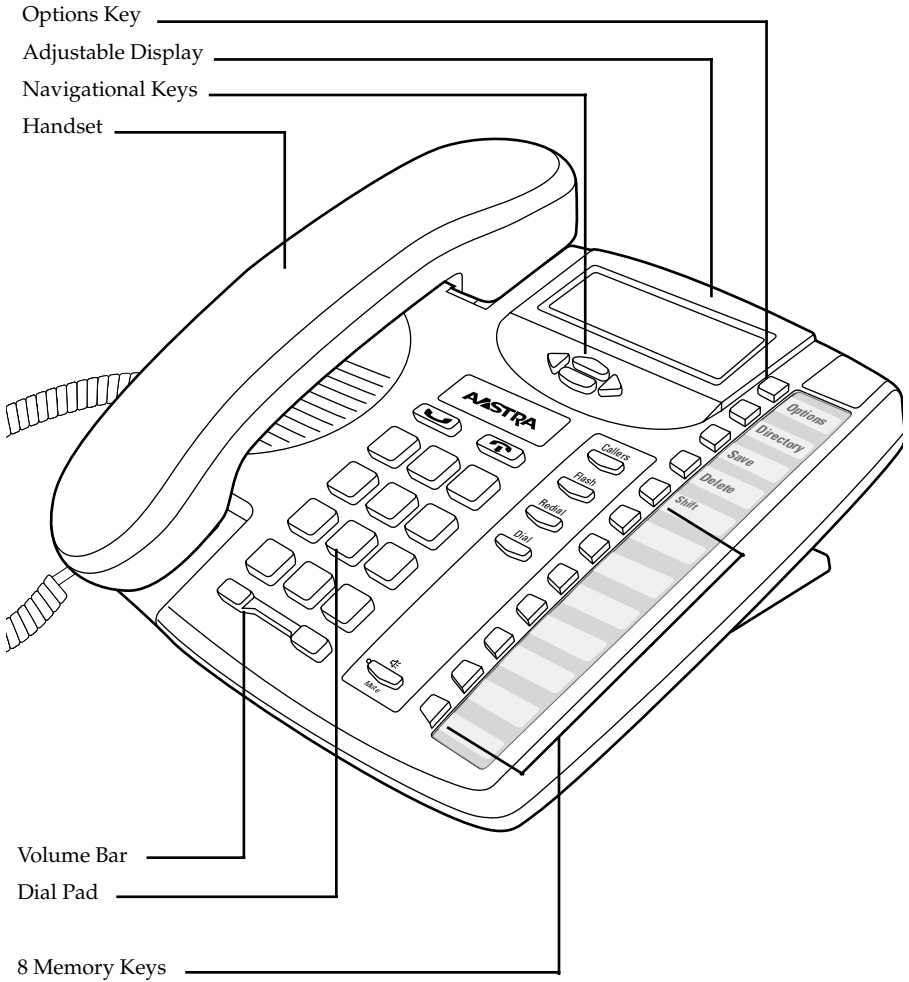











Handset cord

The power adaptor is 9V DC, 300mA - please see the regulatory sheet for safety instructions regarding the power adaptor and operation of the telephone.

Key Descriptions



Keys	Key Description
Set Indicator Light	Flashes when the telephone rings, or when a call is on hold; lights up when a message is waiting or when a feature or extension is in use. See Set Indicator Light on page 10 for more information.
8 Programmable Keys	Stores a name and number or feature for easy access.
<input type="checkbox"/> Options	Access a list of 8 options to customize the features of your telephone.

Keys	Key Description
 <i>Directory</i>	Stores up to 20 names and phone numbers. See Directory on page 11 for more information.
	  allows you to move up or down in the Directory, Callers List, and Options List. When you are editing entries on the display,  moves cursor to the left when entering or editing names or numbers  allows you to insert a space between characters.
	Ends an active call. Goodbye exits an open list, such as the Directory, Options or Callers List. It will not hang up a call that is on hold.
	Places calls on or off hold. See Using the Hold Key on page 7 for more information.
	Sets the handset and speaker volume while on call.
 and light indicators	Activates the speaker and microphone so you can listen and talk without using the handset; also mutes the microphone so that your caller cannot hear you (the light indicator will flash when the microphone is muted). Will also mute the handset when speakerphone is disabled
 <i>Callers</i>	Accesses a list of the last 80 calls received. The list begins with the newest call and ends with the oldest. The oldest call is automatically deleted to make room for the new calls when the list becomes full. See Callers List on page 13 for more information
 <i>Flash</i>	Use with the network features such as Call Waiting and Three Way Calling (flash is also referred to as link).
 <i>Redial</i>	Displays the last number dialed out on the telephone. See Using Redial on page 8 for more information.
 <i>Dial</i>	Dials the displayed telephone number, automatically activates the handsfree mode if the handset is not picked up.
 <i>Save</i>	Use to store numbers and names in Directory, in memory keys and to access and save Option feature settings.
 <i>Delete</i>	Removes entries in the Directory, Callers List or Redial List. Erases memory key information.
 <i>Shift</i>	Use to access the eight two-touch memory positions.
	Memory keys store numbers, names and features. See Memory keys on page 15.

Basic Installation



The 9116LP can be powered from either a PBX line or from the power adaptor supplied with this product. If using the power adaptor, use the following instructions to install this telephone. For information on installation using PBX line power, see the next section.

1. Connect the Handset

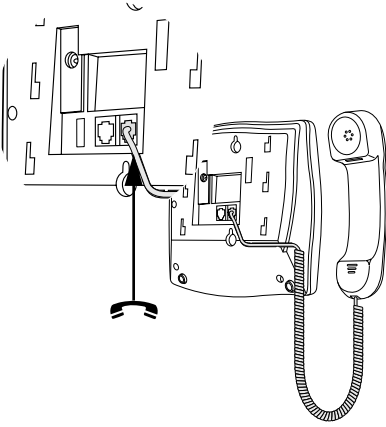
Attach one end of the coiled handset cord to the handset and the other end to the handset port  on the back of the telephone. Route the handset cord along the groove leading off the side of the telephone as shown in the illustration.



2. Connect the Cords

Plug one end of the telephone cord into  on the back of the telephone and the other end to the phone jack. Connect the small end of the power adaptor to the  port on the back of the telephone, and plug the other end into an electrical outlet.

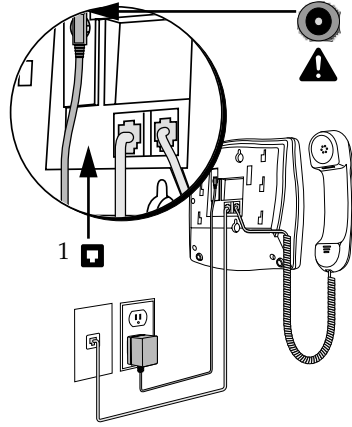

3. Attach the Stand for Desk Mount

If you plan to mount the telephone on the wall, you do not need to attach the stand.

Lower the stand as shown below into the slots on the back of the telephone.

Slide the stand in the direction shown below until it clicks into the locked position.

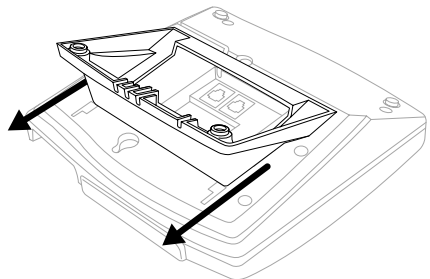
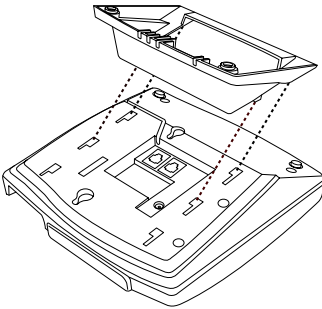

4. Attach the cords to the telephone stand

Route the cords along the groove on the telephone stand as shown in the illustration.

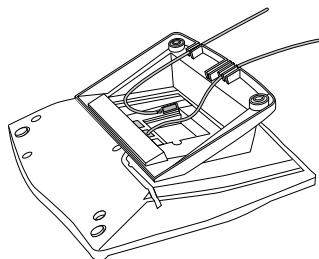
5. Mount the telephone on the wall

It is recommended that you use a wall-mounting plate which is available through your telephone company or a local retailer. You will find it easier to wall-mount the telephone if you purchase one short 20 cm (8") telephone cord and use it in place of the long telephone cord.

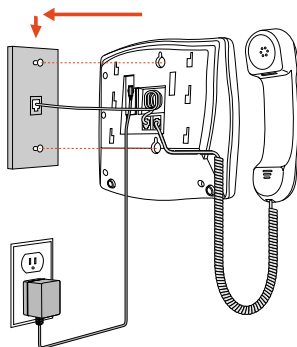

Coil the telephone cord(s) into the space provided on the back of the telephone.

Line up the keys on the wall mounting plate with the key holes on the back of the telephone. Place the telephone onto the wall mounting plate, and then push down to secure the telephone into place.

6. Insert the number card on your telephone

Write your telephone number on the number card.
Place the number card into the slot underneath the handset cradle on the telephone.
Gently bend the clear plastic lens and place it on top of the number card in the slot.

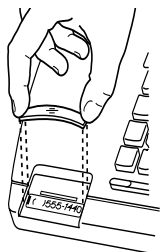
7. Insert the Memory key card on your telephone

This card contains the feature names for the dedicated keys and label identification spaces for the eight programmable memory keys.
Place the card into the memory key card slot on the telephone.
Gently bend the clear plastic lens and place it on top of the memory key card in the slot.
For more information on programming memory keys, refer to **Memory keys** on page 15.

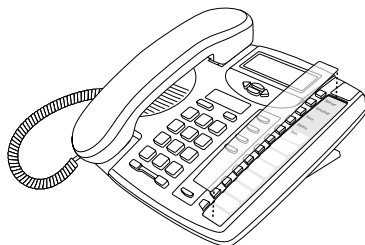

Installation – Line Power PBX

For line power installation, use the same instructions above but without using the supplied power adaptor. Then proceed as follows to activate the phone:

1. Lift the handset from the cradle – time and date is displayed on the screen
2. Press *Options* .
3. Press once. Screen displays **PBX-LINE**.
4. Press *Save* . Display shows **ON OFF**.
5. Use or to change the selection.
6. Press *Save* .

Note: Once line power PBX is activated On, it will activate the Battery Icon.

Important: Operation of the 9116LP in line power mode should be restricted to use behind a PBX line card with no other extensions running off the same line. Should more than one phone be in use on the same line card, it is recommended that the 9116LP be set up using D/C power.

The DC adapter must be connected to the 9116LP if an extension phone is connected to the same telephone line. This will ensure full functionality for the 9116LP (e.g. extension in use)



To avoid potential electrical shock hazard to personnel or damage to the telephone, use **only** the manufacturer-supplied equipment and installation procedures. Specifically, use only 4 conductor modular teledapt plug/cords with this product, and an AC transformer that is CSA/UL or CSA-NRTL/C approved Class 2 level C, rated as follows:

For North American Markets AC voltage 110-120V, Input: 120VAC, 60Hz, 10W and Output: 9V DC, 300mA.

Substitution of non-approved equipment will void the Aastra Telecom Inc., warranty. For more information about installation and safety concerns, call 1-800-574-1611.

Making and Answering Calls

Making a call

With your telephone you can make and answer calls using your handset or  for speakerphone capabilities.

To make a regular call:

1. Lift the handset or press .
8. Enter the number using the dial pad.

Answering a Call



To answer a call:

1. Lift the handset or press .

When you subscribe to the Caller ID service from your telephone company, Caller ID information is sent from the telephone company to your 9116LP telephone between the first and second ring. Therefore, if you want the telephone number of the incoming call to appear on the display and in the Callers List, you must wait until the information appears on the display before answering the telephone.

Using the Hold Key

To put a call on hold and take a call off hold:



1. Make or answer a call.
2. Press . The set indicator light will flash quickly to indicate there is a call on hold.
3. To retrieve the call, press  or . If you don't retrieve the call within 15 minutes, the call is automatically dropped.

Note: The 9116LP automatically releases a call on hold when a person on an extension telephone on the same line picks up the call. If you don't hang up the handset after you have put a call on hold and that call is picked up by someone at another extension, the call is taken off hold but remains connected to your telephone. If this happens, any background noise from your area will be heard by the caller and the person at the other extension.



Making a Handsfree call

You don't have to use the handset to use your telephone. Instead, you can use Handsfree mode to place a call, or you can switch to Handsfree mode while a call is in progress.

To dial without picking up the handset:

1. Press .
2. Enter the number using the dial pad.
3. When the call is over, press .

To switch to a Handsfree call:

1. Lift the handset.
2. Dial a number using the dial pad.
3. When the call is answered, press .
4. Hang up the handset.
5. When the call is over, press .



Muting a handsfree call



You can turn off the microphone so that the caller can't hear you but you can still hear the caller. Muting a call only works when you are in Handsfree mode.

To mute a handsfree call:

1. Press .

2. Without lifting the handset, make a call.

3. To turn off the microphone, press . You can hear your caller but your caller cannot hear you. The light beside  flashes.

4. To speak to your caller, press  again. Each time you press , you turn the microphone on or off.

5. When the call is over, press .

Disable Handsfree Option

In many "open concept" offices, speakerphone usage is not a practical alternative. For such environments, the 9116LP can be programmed to disable the speakerphone. As the telephone is shipped with the speakerphone enabled, use the following steps to disable (or activate) the speakerphone.

To disable (or to activate) the speakerphone

1. Using the instructions for **Setting the date and time** on page 10, change the date and time to 1/01 12:00AM and save.



2. Press  *Options*.

3. Press .

4. Press  key within 4 seconds.



Note: If the speakerphone is Disabled then the  key will mute the Handset with the Flashing LED accordantly.

Using Redial

Pressing  displays the last number dialed. When you press  the last number you called appears on the screen.

To make a call using Redial:



1. Press . The display shows the last number you dialed.

2. Lift the handset or press either  or .

Call Waiting ID[†]

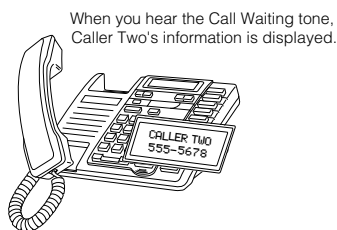
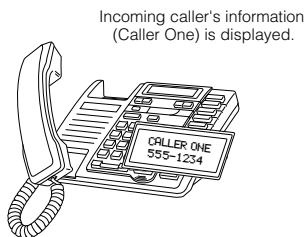
The 9116LP is capable of displaying Caller ID information of a second incoming call while you have a call in progress. When you are on a call and you hear the Call Waiting tone, the Call Waiting information is displayed as shown below.









If you decide you want to speak to the new caller, simply press . Your first call will not be disconnected. You may switch between callers as often as you like by pressing . When you press  and see a caller's Identification information but only hear a dial tone, it means that the caller has hung up. Your second call will be stored in the Callers List even if it is not answered. For more information about stored calls, see **Callers List** on page 13.

Changing the display language

For changing business requirements, you may wish to change the language of your display messages and prompts. There are three language choices available for your telephone (English, French and Spanish).

To change the display language:

1. Press  *Options* .
2. Press  once and **Set Language** appears on the display.
3. Press  *Save* . The language indicators **E**, **F**, **S** appear on the display for English, French and Spanish. The current selection is indicated by the flashing letter.
4. Use  or  to change the selection.
5. Press  *Save* .



[†] You must subscribe to your telephone company for the Call Waiting with Calling ID service.





Setting the date and time

If you subscribe to the Caller ID service from your telephone company, the date and time are set automatically after you receive your first incoming call. If you do not subscribe, you must set the date and time manually.

To set the date and time:

1. Press  *Options* .

2. Press  or  until display indicates **Set Time/Date**.

3. Press  *Save* . Display shows time and date. Use  and  to adjust the flashing time and date and   to move to the next field. To change the AM/PM indicator, adjust the time ahead by 12 hours.

4. Press  *Save* .

To resume the automatic date and time setting (if the date and time has been set manually), disconnect the power supply (or the line cord if the phone is PBX powered), then re-connect it. After your first incoming call, the date and time are automatically set if you subscribe to the Caller ID service from your telephone company.

Adjusting the Handset and Speaker volume

Press the left or right side of the volume bar  to adjust the volume on the handset or speaker. The speaker volume remains at the level selected until the next time you change it.

Adjusting the Ringer Volume



The ringer volume is controlled by a three position switch on the back of the Model 9116LP. The ringer volume can be set to be off, low or high.



Adjusting the Display Contrast

The contrast on the display screen can be adjusted as required to compensate for lighting conditions.

To adjust the display contrast:

1. Press  *Options* .

2. Press  or  until screen displays **Set Contrast**.

3. Press  *Save* . Display shows **123456**. Use  and  to move the flashing line to adjust the contrast to the desired level.

4. Press  *Save* .

Set Indicator Light

The set indicator light, located on the top right hand corner of the Model 9116LP, flashes and illuminates to provide information as follows:

Set indicator light is on.	Extension phone is in use.
Set indicator light flashes very quickly.	Incoming call.
Set indicator light flashes quickly.	Line is on hold.
Set indicator light double flashes.	Message Waiting*.

* You must subscribe to Voice Mail features from your telephone company for this feature to work.













Directory

The 9116LP telephone directory can store the names and telephone numbers of up to twenty of your business associates, clients, contacts and friends for easy dialing.

Each directory record is numbered and identified by the number appearing in the bottom, right hand corner of the screen display. Names and numbers can be manually entered into the Directory using the keypad or transferred into the Directory from the screen display.





If all twenty directory records are used, the display will indicate **DIRECTORY FULL**. (See **Deleting items from the Directory** on page 12).

Saving numbers and names to the Directory









To save or edit a number and name:	To save from the display:
1. Press  . The screen displays DIRECTORY IS EMPTY or XX ITEMS .	1. Ensure that a number is on the display (for example from the Callers List).
2. Press  . The screen prompts you to enter the phone number you wish to save.	2. Press  . The display indicated SAVE TO? .
3. Enter the number using the dial pad. You can enter a maximum of 16 digits. If you need to add a pause (for example between a telephone number and an access code) press  and the Pause icon will appear. To program a number that uses Flash, press the  key where required and the Flash icon will appear.	3. Press  again. The screen shows ENTER NUMBER .
4. Press  . The screen prompts you to enter the name you wish to save. Use the dialpad to enter a name. See Entering Names on page 11.	4. Press  again. The screen indicates ENTER NAME . If there is already a name associated with the number or you do not wish to have a name with this directory entry, go to the next step. Use the dialpad to enter the name if required. See Entering Names on page 11.
5. Press  . The display shows SAVED:DIRECTORY .	5. Press  . The display shows SAVED:DIRECTORY .
6. Press  to exit the Directory.	6. Press  to exit the Directory.

Entering Names



You can program names to correspond with numbers you have entered into the Directory or a memory key. The following paragraphs explain how to enter letters using the dial pad. Before you can use the dial pad to enter names, you must first save or edit a number in the Directory or memory key.





To program a name, find the dial pad key that has the first character of the name. Keep watching the display as you press the key until that character appears on the display. Press a different dial pad key for the next character. If the next character is on the same key, press  to move to the next space or wait a few seconds and it will automatically advance to the next space. To insert a space, press . To backspace and erase a mistake, press  and  *Delete*.





For example, to enter the name RUTH press these keys:

  ,  , ,   .

If you wish to change a digit or letter after you have entered it, press  to erase it.







 , - ' & () 1
 G H I 4
 P Q R S 7



 A B C 2
 J K L 5
 T U V 8

 D E F 3
 M N O 6
 W X Y Z
 0

Making a call from the Directory





To make a call from the Directory:

1. Press .
2. Press  or  or use the dial pad to find the item you want to dial out.
3. Lift the handset or press either  or .
4. To end the call, press  or hang up.

Note: To leave the Directory at any time, press .





Finding items in the Directory

To find items in the Directory:





1. To see the Directory List heading, press .
2. Use the  and  to look at each individual directory entry one at a time.
3. To leave the Directory at any time, press .

Deleting items from the Directory

To delete individual items:

1. Press .
2. Press   to find the item you want to delete.
3. Press  twice. Selected item is deleted.
4. Press  to exit the Directory at any time.

To delete all items:

1. Press .
2. Press , the screen indicates DELETE ALL?.
3. Press  again to confirm deletion of the entire Directory.
4. Press .

Callers List[†]







Using the Callers List

The 9116LP telephone stores up to 80 calls in the Callers List. Your telephone logs the number (and name if available) of the caller, when they last called, and the number of times they tried to reach you. When the Callers List is full, the oldest call records are deleted to accommodate the information of new callers. See **Display messages** on page 21 for a description of the display messages.

If the telephone number of the incoming call matches a number that you have programmed with a name in a memory key or the Directory, the Callers List shows the name you have saved in the memory key or Directory, and the number.







Finding a Callers Record in the Callers List

To find items in the Callers List:

1. Press . The display shows the number of items (Caller Records).
2. Press  to view other caller records one at a time starting from the second most recent caller. To view from the oldest caller record to the most recent press . The screen may display **XX ITEMS** but continue to press  or  to see the oldest call records.
3. Press  to leave the Callers list.

Making a call from the Callers List

To dial a number in the Callers List:

1. Press . The display shows the number of items (Caller Records).
2. Press  or  to find the caller record you wish to dial to.
3. Lift the handset or press either  or .
4. To end the call, press  or hang up.







If you call a number from the Callers List and you don't get connected, you may have to edit the number (for example, the number may be long distance and you may have to add "1").

Tip: If you frequently have to remove area codes to return local calls, use the Area Codes option to avoid this situation. See **Set Area Code** on page 19 for more information.







[†] You must subscribe to your telephone company for the Caller ID service.

Editing in the Callers List

To edit a number in the Callers List:





1. Press .
2. Press  keys to find the Caller record you wish to edit.
3. Use the dial pad to add digits. Added digits will appear to the left of the cursor. Press  to erase a digit and all digits to the right of the cursor will move one position to the left. To add a pause press . To add a Flash feature to a number, press .
4. To dial the edited number, immediately lift the handset or press  or  as soon as editing of the number is complete.
5. To save the edited number in the Directory rather than dialing it, go to step 3 below.

To copy a number from the Callers List to the Directory or to a memory key:





1. Press .
2. Press  keys to find the Caller record you wish to copy.
3. Press . Display shows **SAVED TO?**.
4. Press  or the memory key (or  plus a memory key) where you want to store the number.
5. The screen indicates **ENTER NUMBER**.
6. Press  again. If no name is displayed or if there is a displayed name, you are prompted to enter one. The screen indicates **ENTER NAME**. To enter or change a name, use the dial pad. (See **Entering Names** on page 11). If you don't want to add or change the name, go to step 7.
7. Press .
8. If saved to Directory, the screen indicates **SAVED: DIRECTORY**. If saved to a memory key it indicates **SAVED: MEMORY KEY**.

Deleting from the Callers List

To delete a number in the Callers List:

1. Press . The screen displays the number of items.
2. Press the  to find the Caller Record you wish to delete.
3. Press . The display indicates **PRESS DELETE**, press  again.
4. Press  to exit the Callers List or simply wait a few seconds and the phone automatically exits the Callers List.

To delete all numbers in the Callers List:

1. Press . The screen displays the number of items.
2. Press  until the display indicates **DELETE ALL?**
3. Press  again and the display briefly will indicate **LIST EMPTY**.
4. Press , the display will briefly indicate **NO CALLS**.

Memory keys

Saving numbers and names into memory keys



You can save up to 15 speed dial numbers and names of your customers, business associates, or anyone you call frequently in the 9116LP's eight memory keys. You can store more numbers and names in the Directory. See the **Directory** on page 11 for more information.

To save or edit a number and name in a memory key:

1. For a one touch memory key, press any of the seven lower memory keys. The screen will show **EMPTY** or whatever name and number has already been programmed into the memory key. For a two touch memory key, press the  (display will show **SHIFT**) and then one of the memory keys.

2. Press . Display indicates **SAVE TO?**.

3. Press . Display indicates **ENTER NUMBER**.

4. Enter the number using the dialpad. You can enter up to 16 digits. To add a pause to a number, press . To add Flash to a number, press .

5. Press . Display indicates **ENTER NAME**. If you do not wish to add a name for the Memory key, go to the next step. To add a name, use the dialpad. See **Entering Names** on page 11.

6. Press . The display shows **SAVED: MEMORY KEY**.

Note: You can also program a memory key by copying a caller record in the Callers List. See **To copy a number from the Callers List** on page 14.

Viewing memory key contents

To view an item in the memory key:

1. Press the memory key or the  plus the memory key to view the contents of that key.

2. Display screen will show any number and name programmed to that key. Display will briefly indicate **EMPTY**.



Labeling the memory keys

Your Memory key card has label identification spaces (shaded in grey) for each of the eight programmable memory keys. Write the name of the autodialer or feature on these spaces when you program a memory key.





Making calls from memory keys

To call from a memory key:

1. Lift the handset or press  or .
2. Press the memory key, or  plus the memory key to obtain the number you wish to dial.

To predial from a memory key:

1. Press the memory key, or  plus the memory key to obtain the number you wish to dial.
2. Lift the handset or press either  or .

Deleting memory keys

To delete a memory key:

1. To see its contents, press the memory key.
2. To erase, press  twice.

Saving features in memory keys[†]

For easy access, you can save the feature codes of telephone company services in your memory keys. This works well with network features such as Call Forwarding and Call Return. Some features require an On and Off code in two separate keys, while other features are stored on only one key. The following procedures show you how to save both an On and Off code.

To save a Feature On code:	To save a Feature Off code:
1. Press the memory key where you want to save the number.	1. Press the memory key where you want to save the number.
2. Press <input type="checkbox"/> Save .	2. Press <input type="checkbox"/> Save .
3. Enter the telephone company feature code for turning the feature on. [†] Read the display to confirm the number.	3. Enter the telephone company feature code for turning the feature off. [†] Read the display to confirm the number.
4. Press <input type="checkbox"/> Save .	4. Press <input type="checkbox"/> Save .
5. Enter the feature name using the dial pad. (See Entering Names on page 11.)	5. Enter the feature name using the dial pad. (See Entering Names on page 11.)
6. Press <input type="checkbox"/> Save .	6. Press <input type="checkbox"/> Save .
7. Label the memory key.	7. Label the memory key.

[†]**Note:** Contact your telephone company for the appropriate feature codes.

Saving a feature and light in memory keys

You can make the set indicator light come on when you turn a feature on and go off when you turn that same feature off. You can only do this with one feature, and the feature must have separate On and Off codes (such as Call Forwarding).





For example, you may want the light to remind you that you have turned Call Forwarding on. To do this, use one key to turn the indicator light on when you activate the feature. Use the second key to turn the indicator light off when you deactivate that same feature. The following procedure shows you how to program a FeatureLight On and Off key.

[†] You must subscribe to your telephone company for Custom Calling Features.





Using Feature Light keys

Pressing the memory key will automatically dial the feature code and put the telephone in Handsfree mode.

To save a FeatureLight On key:

1. Press  *Save*, the display indicates **SAVE TO?**
2. Press the desired memory key. The display indicates **ENTER NUMBER.**
3. Enter the telephone company feature code for turning the feature on.
4. Read the display to confirm the number.
5. Press  *Save*, the display indicates **ENTER NAME.**
6. Press  the display indicates **FTR LIGHT ON.**
7. Press  *Save*, the display indicates **SAVED: MEMORY KEY.**
8. Label the memory key.



To save a FeatureLight Off key:

1. Press  *Save*, the display indicates **SAVE TO?**
2. Press the desired memory key. The display indicates **ENTER NUMBER.**
3. Enter the telephone company feature code for turning the feature of.
4. Read the display to confirm the number.
5. Press  *Save*, the display indicates **ENTER NAME.**
6. Press  the display indicates **FTR LIGHT OFF.**
7. Press  *Save*, the display indicates **SAVED: MEMORY KEY.**
8. Label the memory key.

Note: Contact your telephone company for the appropriate feature codes.

Advanced Features





To turn a feature and light on or off:

1. Press the memory key where you stored the FeatureLight. The display shows **FTR LIGHT ON** or **FTR LIGHT OFF**.
2. Lift the handset or press either , . The feature and light turn on or off. (When the feature and light are on and you're not using the telephone, the display shows **Feature ON**.)

Clear Message Waiting

On occasion, the light indicator and the  icon will stay on even though there are no messages in your Voice Mail service. You can use the following procedures to clear the display and the light indicator.









To clear Message Waiting indication:

1. Press  *Options* .
2. Use  or  until it indicates **CLR MSG WAITING**.
3. Press  *Delete* .

Set Area Code

The 9116LP allows you to save an up to three digit area code that will be stripped when dialing a number from the Callers List. For example, if you enter your own area code using this option, any Callers List entries with your same area code will be dialed as a seven digit number, even though they will appear on the display with the area code showing. For example, let's assume your area code was 111, and you set this area code using this option. Any number in the Callers List with the same 111 area code would be dialed out from the Callers List as a seven digit number, without dialing the area code. Note that the number would still appear in the Callers List and on the display with the full number, but when dialed would appear on the first line of the display screen as a seven digit number.







To set the area code:

1. Press  *Options* .
2. Use  or  until it indicates **SET AREA CODE**.
3. Press  *Save* . Display indicates three positions -- --.
4. Use  and  to select a digit. Use  and  to move to the next position.
5. Press  *Save* .

Turning the Call timer on or off

You can program the call timer to always appear on the 3rd line of the telephone display instead of the date and time. The call time will appear 5 seconds once the phone is off hook.







To turn the Call timer on or off:

1. Press  *Options* .
2. Use  or  until it displays **CALL TIMER**.
3. Press  *Save* . Display shows **ON OFF**.
4. Use  or  to change the selection.
5. Press  *Save* .

Display Icons and Messages

The Model 9116LP telephone has a three-line display that uses both icons and text messages to supply call information.

Icons in the Callers List

	Voice message waiting [†]
	Phone is not in use
	Phone is in use
	Incoming call
	Incoming call waiting call [†]
	Phone is Line Powered

[†]This service may have a different name in your area. Contact your telephone company for information.

Display messages

Here are some common screen display messages. For more information on other display messages, check the appropriate section of this user guide when using the telephone.

Message	What it means
XX NEW CALL	XX new calls have been added to the Callers List since last checked.
DIRECTORY FULL	All locations in the Directory are used.
MESSAGE WAITING	Voice message waiting.
KEY IS EMPTY	No item stored in the Memory key.
DELETE ALL?	Prompt to delete all Directory or Callers List entries.
ENTER NUMBER	Prompt to enter a telephone number for saving in Directory or Memory Key.
PRIVATE CALL	Caller has requested their caller information to be suppressed.

Troubleshooting

The display is blank on my phone

You may have more than one 9116LP connected to a line card while using line power mode. Try using the power adapter supplied with the phone to resolve this problem.

The display is blank on my phone and the ringer volume is low

If using the power adapter, check to ensure that it is connected properly to the phone and connected to a working electrical outlet. You can test the outlet with another device, such as a lamp.

The speakerphone does not work

The handsfree speakerphone may have been intentionally disabled by your Company to meet internal requirements. If speakerphones are allowed, see **To disable (or to activate) the speakerphone** on page 8 for instructions.

The display is in the alternate language.

See page 9 for instructions to change the display language.

The cursor doesn't move when saving in the Directory.

The number or name is too long. Numbers and names can be no longer than 16 characters.

I cannot hear a caller.

Make sure the handset cord is inserted securely into the jack and make sure the receiver volume is high enough.

The telephone wobbles.

Check that the handset cord is placed in the channel between the stand and the telephone. See the illustration on page 5.

I cannot program a memory key.

Some of the memory keys may be factory-programmed. These keys are locked and cannot be erased or reprogrammed.

Callers are not identified on the display.

Let the telephone ring at least twice before answering. If that doesn't work, you may not have a Calling Line Identification[†] service. To subscribe, contact your local telephone company.

The Callers List is empty.

Until you subscribe to Calling Line Identification[†] service, your telephone does not record incoming calls.

I cannot dial a number in the callers list.

The caller may have an unknown number.

How do I answer Call Waiting?

To answer a Call Waiting call, press . You may have to subscribe to a Call Waiting[†] service to use this feature.

[†] This service may have a different name in your area. Contact your telephone company for information.

A

Answering a call 8

C

Call Display

see Calling Line Identification

Call Waiting Identification 9

Callers List

deleting in 14

finding items 13

making a call 13

saving to the Directory or a memory key 14

Calling

from a memory key 16

from the Callers List 13

from the Directory 12

from the Redial List 8

Calling Line Identification 7, 9, 10, 13, 22

Calls

holding 7

muting 8

D

Date and time 10

setting 10

Deleting

Directory items 12

items in the Callers List 14

memory keys 16

Dial pad

entering names 11

Directory 11

deleting items 12

editing 12

entering names 11

finding items 12

making a call 12

Display

language

changing 9

messages

Callers List 22

E

Editing

the Callers List 14

H

Handsfree 7

Helpful hints

see Troubleshooting 22

Hold 7

I

Installation 4

K

Key descriptions 2

L

Language

see Display language 9

Letters

entering 11

M

Memory keys 15

cannot program 22

deleting 16

editing 16

making calls from 16

predialing from 16

saving Feature/light to 19

saving features 17

Mute 8

N

Names

entering 11

R

Redial

List 8

S

Save key 3

Saving

feature codes to memory keys 17

names and numbers

to memory keys 15

to the Directory 11

Setting

date and time 10

T

Timer key

adding 19

Troubleshooting 22

V

Viewing items

Callers List 21

Volume

muting a handsfree call 8

GENERAL INQUIRIES

If you have read the guide and you still have questions, call 1-800-574-1611 in Canada and the USA. In other areas, contact your telephone company.